

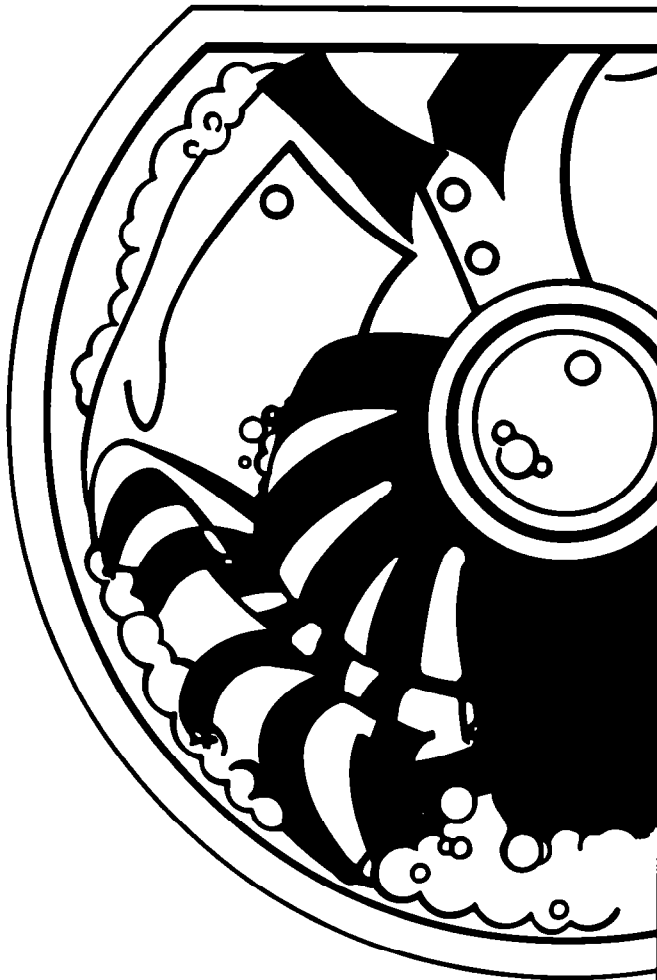

Use And Care

GUIDE



| | |
|---|----|
| A Note to You | 2 |
| Washer Safety | 3 |
| Parts and Features | 4 |
| Operating Your Washer | 5 |
| Starting your washer | 5 |
| Stopping/restarting your washer | 6 |
| Selecting a cycle and time | 7 |
| Using Rinse and Spin | 8 |
| Using Drain and Spin | 8 |
| What happens in each cycle | 9 |
| MAGIC CLEAN* lint filter | 9 |
| Adding liquid chlorine bleach | 10 |
| Adding liquid fabric softener | 11 |
| Caring for Your Washer | 12 |
| Laundry Tips | 13 |
| Removing Stains | 17 |
| Troubleshooting | 20 |
| Requesting Assistance or Service | 22 |
| Warranty | 24 |

TWO SPEED AUTOMATIC WASHER

PART NO. 3363836

8/95

A Note to You

Because your life is getting busier and more complicated, WHIRLPOOL* washers are easy to use, save time, and help you manage your home better. To ensure that you enjoy years of trouble-free operation, we developed this Use and Care Guide. It contains valuable information about how to operate and maintain your washer properly and safely. Please read it carefully.

Please record your model's information.

Whenever you call to request service on your appliance, you need to know your complete model number and serial number. You can find this information on the model and serial number plate (see diagram on page 4 for location of plate).

Please also record the purchase date of your appliance and your dealer's name, address, and telephone number.

Model Number _____

Serial Number _____

Purchase Date _____

Dealer Name _____

Dealer Address _____

Dealer Phone _____

Keep this book and the sales slip together in a safe place for future reference.

Washer Safety

Your safety is important to us.

This guide contains safety statements under warning symbols. Please pay special attention to these symbols and follow any instructions given. Here is a brief explanation of the symbol.

⚠WARNING

This symbol alerts you to such dangers as fire, electrical shock, burns, and personal injury.

IMPORTANT SAFETY INSTRUCTIONS

⚠WARNING

To reduce the risk of fire, electrical shock, or injury when using your washer, follow basic precautions including the following:

- Read all instructions before using your washer.
- Do not machine wash or machine dry items cleaned, washed, soaked in, or spotted with wax, paint, gasoline, oil, or other flammable fluids. The fumes can create a fire hazard or explosion. Always hand wash and line dry items containing these materials.
- Flammable fluids (dry-cleaning solvents, kerosene, gasoline, etc.) should not be used or stored in or near your washer. Do not add flammable fluids to your wash water. These substances give off vapours that can create a fire hazard or explosion.
- Do not allow children to operate, play with, or crawl on or inside your washer. Supervise children closely when your washer is used near them.
- Before your washer is removed from service or discarded, remove the lid to prevent accidental entrapment.
- After starting a cycle, do not reach into the basket unless the Cycle Control Knob is pushed in and all motion stops.
- Do not tamper with the controls.
- If your hot water has not been used recently (usually 2 weeks or longer), hydrogen gases may build up in your water heater and your hot water pipes. **HYDROGEN GAS IS EXPLOSIVE.** To prevent injury or damage, before using your washer, turn on all hot water faucets and allow water to run for several minutes. This will allow gases to escape. Do not smoke or use any open flame near your faucet while it is open.

Please ...

- Have only a qualified person install, repair, or replace parts on washer.
- Maintain washer properly.
- Protect washer from the weather and keep it where the temperature will not fall below freezing.
- Install and level washer on a floor that can support the weight.†
- Connect washer to the correct 3-prong outlet, electrical supply, water supply, and drain.†
- Ground washer properly.†

† See the Installation Instructions.

– SAVE THESE INSTRUCTIONS –

Understanding your responsibilities

- Store laundry aids and other materials in a cool, dry place where children cannot reach them (in a locked cabinet if possible).
- Read and follow instructions on packages of detergent and laundry aids, especially warnings and precautions.
- Do not wash or dry items that are soiled with vegetable or cooking oil. These items may contain some oil after laundering. Due to the remaining oil, the fabric may smoke or catch fire by itself.
- Do not use chlorine bleach and ammonia or acids (such as vinegar or rust remover) in the same wash. Hazardous fumes can form.
- Unplug power supply cord before attempting to service your washer.
- Do not machine wash fiberglass materials. Small particles can stick to fabrics washed in following loads and cause skin irritation.

Parts and Features

The parts and features of your washer are illustrated on this page. Become familiar with all parts and features before using your washer.

NOTES:

- The drawings in this book may vary from your washer model. They are designed to show the different features of all models covered by this book. Your model may not include all features.
- Page references are included next to some features. Refer to those pages for more information about the features.

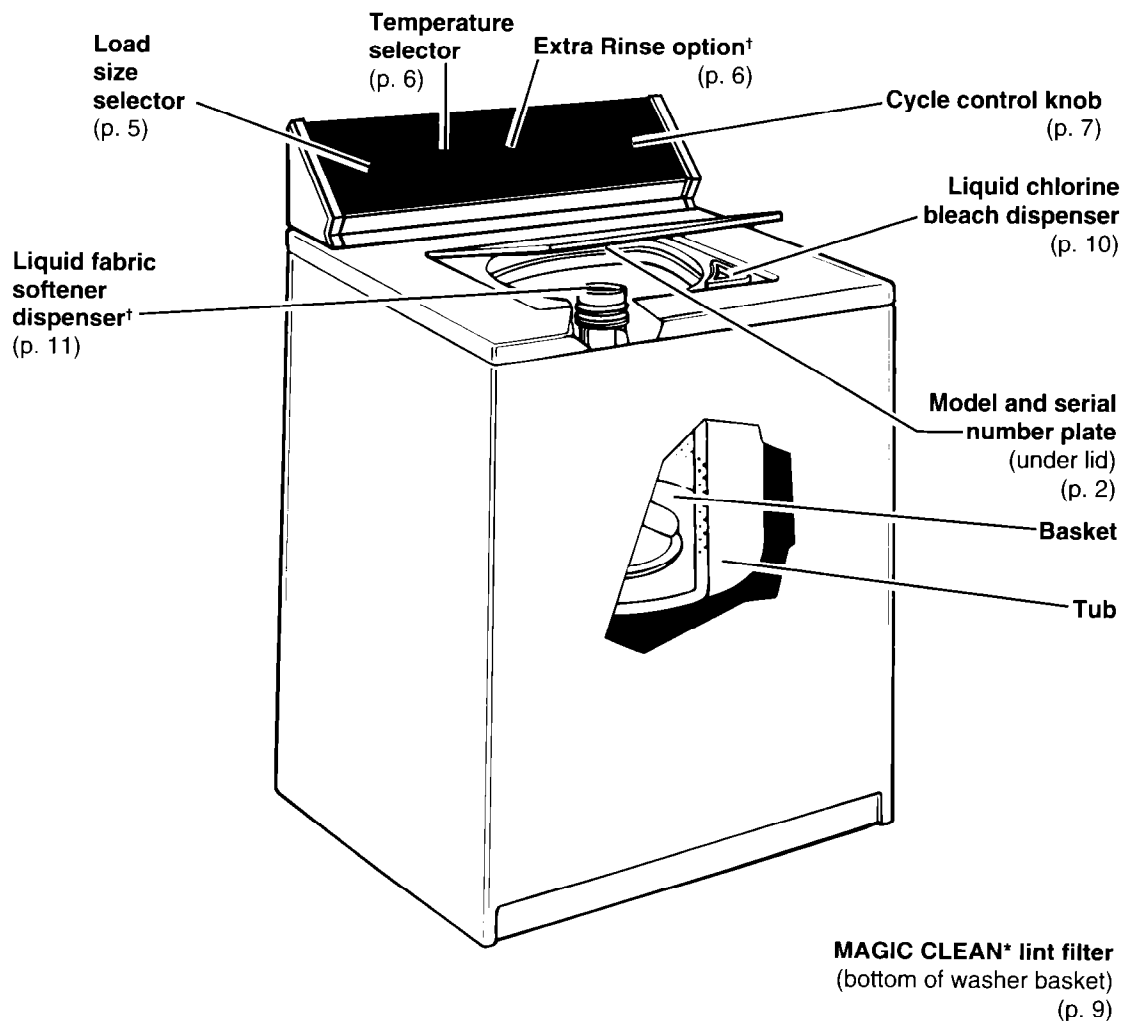

†Available on some models

Operating Your Washer

To obtain the best washing results, you must operate your washer properly. This section gives you this important information. Page references are included for more information.

Starting Your Washer

- 1. Add measured detergent to the washer. Then place a sorted load of clothes in the washer.**
 - Sort and load clothes as described on pages 13 and 14.
 - If desired, you may also add colour safe bleach.
- 2. (OPTIONAL STEP) Add measured liquid chlorine bleach to the liquid bleach dispenser.** Use only liquid chlorine bleach in the bleach dispenser. See page 10.
- 3. (OPTIONAL STEP) On models with a liquid fabric softener dispenser, add measured liquid fabric softener to the dispenser.** See page 11.
 - If your model does NOT have a liquid fabric softener dispenser, see Step 10 and page 11.
- 4. Close the washer lid.**
- 5. Select a load size setting that corresponds with the size of your wash load and the type of fabric being washed.** See pages 13 and 14 for loading tips.

Your washer has either a **slide** or **rotary knob** Load Size Selector.

 - For a **slide** Load Size Selector, choose a setting anywhere on or between extra small and extra large.

To change the load size setting after the washer has started to fill, first slide the Selector to RESET, then to the desired new setting.
 - If your washer has a **rotary knob** Load Size Selector, turn the Selector to the desired setting.

To change the load size setting after the washer has started to fill, turn the Selector to the desired new setting.

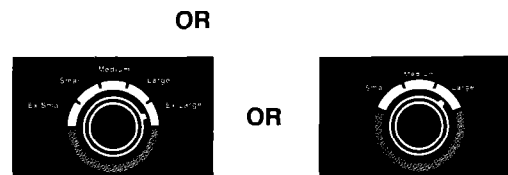
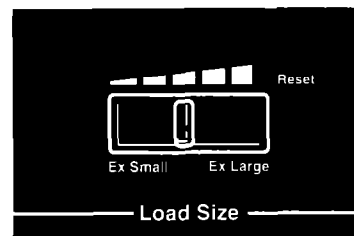
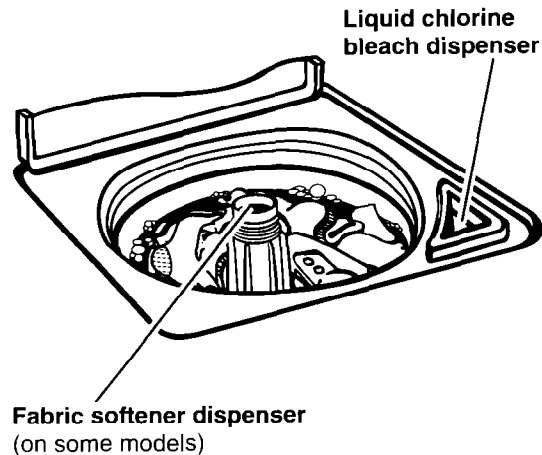

continued on next page

OPERATING YOUR WASHER

6. Select a wash-rinse temperature with the **Water Temperature Selector**. Match the water temperature with the type of fabric and soils being washed.

- Your washer has one of the Water Temperature Selectors shown: **rotary knob**, **push-button**, or **CLEAN TOUCH**[†].
- For all Selectors, the top temperature is the wash water, and the bottom temperature is the rinse water.
- See page 15 for water temperature tips.

7. (OPTIONAL STEP) On models with the **Extra Rinse Option**, set the **CLEAN TOUCH Extra Rinse Selector** to **On** to add an additional rinse and spin to the end of the wash cycle.

- Use the Extra Rinse Option when adding extra detergent for the Super Wash cycle, or any other cycle, depending on your model.

8. Push in the **Cycle Control Knob** and turn it clockwise to the wash cycle you want.
9. Pull out the **Cycle Control Knob** to start the washer
10. (OPTIONAL STEP) If desired, add measured liquid fabric softener to the rinse water. See page 11.

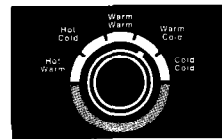

Rotary knob

OR

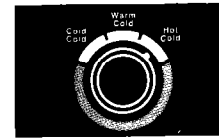

Rotary knob

OR

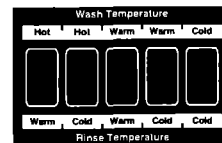

Push-button

OR

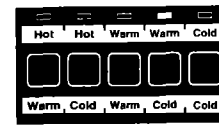

CLEAN TOUCH

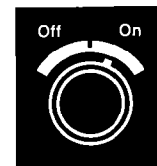

OR

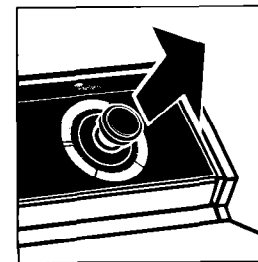
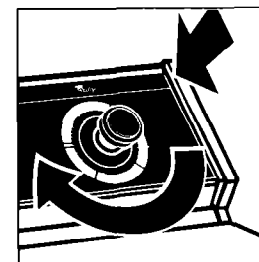
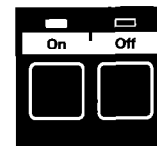

Stopping/restarting your washer

- To **stop** the washer at any time, push in the Cycle Control Knob.
- To **restart** the washer, close the lid (if necessary) and pull out the Cycle Control Knob.

Selecting a cycle and time

The Cycle Control Knob shown below may vary from the Cycle Control Knob on your washer. The Knob shown illustrates the different features of all washer models covered by this book. Your model may not include all of the cycles shown.

Each cycle is designed for different types of fabrics and soil levels.

- An Extra Rinse option is available (on some models) in the Regular and Permanent Press cycles. See page 6.

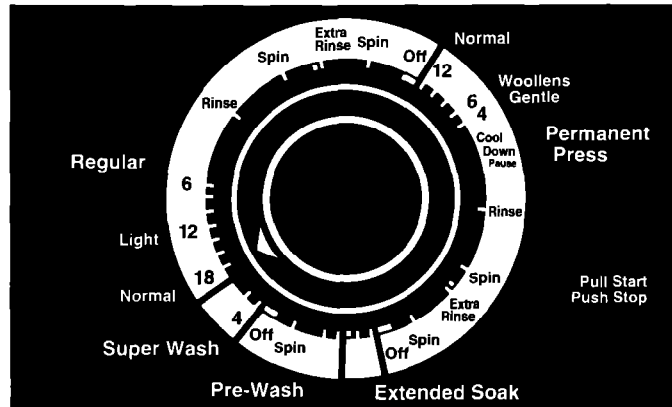

Super Wash Cycle

The Super Wash cycle automatically prewashes the load and advances into the Regular cycle (the washer does not have to be reset after the Super Wash cycle). Use this 4-minute cycle to clean heavily soiled loads that need maximum soil removal.

NOTE: For proper cleaning, use double the amount of detergent recommended for the load size.

Regular Cycle

The Regular cycle features the Gentle Wash system and high spin speeds to shorten drying time.

- Use the 18-minute NORMAL cycle to clean sturdily-constructed cotton and linen fabrics that are heavily soiled.
- Use the 12-minute LIGHT cycle to clean sturdily-constructed cotton and linen fabrics that are moderately soiled.
- Use 6 minutes of wash time to clean sturdily-constructed cotton and linen fabrics that are lightly soiled.

Permanent Press Cycle

The Permanent Press cycle features the Gentle Wash system, a cool-down rinse, and low spin speeds to reduce wrinkling.

- Use the 12-minute NORMAL cycle to clean permanent press and some synthetic fabrics that are moderately soiled.
- The 6-minute WOOLLENS cycle (available on some models) features a low agitation speed to clean washable woollens and knits that are lightly soiled.

NOTE: Select warm wash and warm rinse water (if available) when using this cycle.

- The GENTLE cycle features a reduced agitation speed for gentle soil removal and shorter spins to reduce wrinkling. Use this 4-minute cycle to clean delicate items and washable knits that are lightly soiled to moderately soiled.

OPERATING YOUR WASHER

Extended Soak Cycle

The Extended Soak cycle features brief periods of agitation and soak time to help remove heavy soils and stains that need pretreatment.

- Use warm water when soaking laundry (hot water can set stains). See pages 17-19 for stain removal information.
- Use the amount of detergent or presoak additive recommended by manufacturer.
- After the Extended Soak cycle ends, add detergent and set a new wash cycle.

Pre-Wash Cycle

The Pre-Wash cycle features a brief period of high speed agitation to help remove heavy soils and stains that need pretreatment.

- Use warm water for prewashing stained laundry (hot water can set stains). See pages 17-19 for stain removal information.
- After the Pre-Wash cycle ends, add detergent and set a new wash cycle.

Using Rinse and Spin

NOTE: An Extra Rinse option is available on some models. See page 6.

When using extra detergent for heavily soiled clothes, or washing special-care items, you may find an extra rinse and spin is needed.

1. Push in the Cycle Control Knob and turn clockwise to RINSE, as illustrated.
2. Pull out the Cycle Control Knob. The washer fills to selected load size, agitates, drains, and spins.

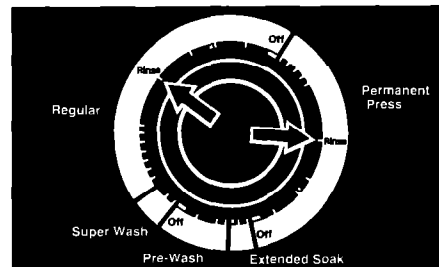

Using Drain and Spin

A drain and spin may help shorten drying times for some heavy fabrics or special-care items by removing excess water.

1. Push in the Cycle Control Knob and turn clockwise to SPIN, as illustrated.
2. Pull out the Cycle Control Knob. The washer drains, then spins.

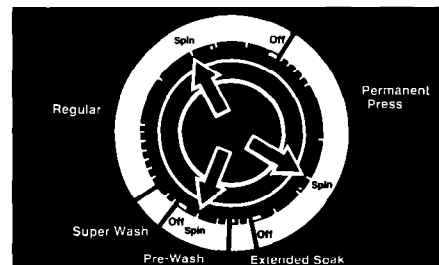

What happens in each cycle

When the Cycle Control Knob is set to a number and pulled out, the washer fills (to selected load size) before agitation and timing start. The washer begins agitating immediately after filling (agitation occurs with the washer lid up or down). After agitation starts, the Cycle Control Knob turns clockwise until it points to OFF and the cycle ends.

NOTES:

- A Gentle Wash system helps protect your fabrics by reducing wash agitation speed during the last few minutes of wash agitation in the Regular and Permanent Press cycles.
- The washer pauses briefly throughout each cycle. These pauses are normal for washer operation.

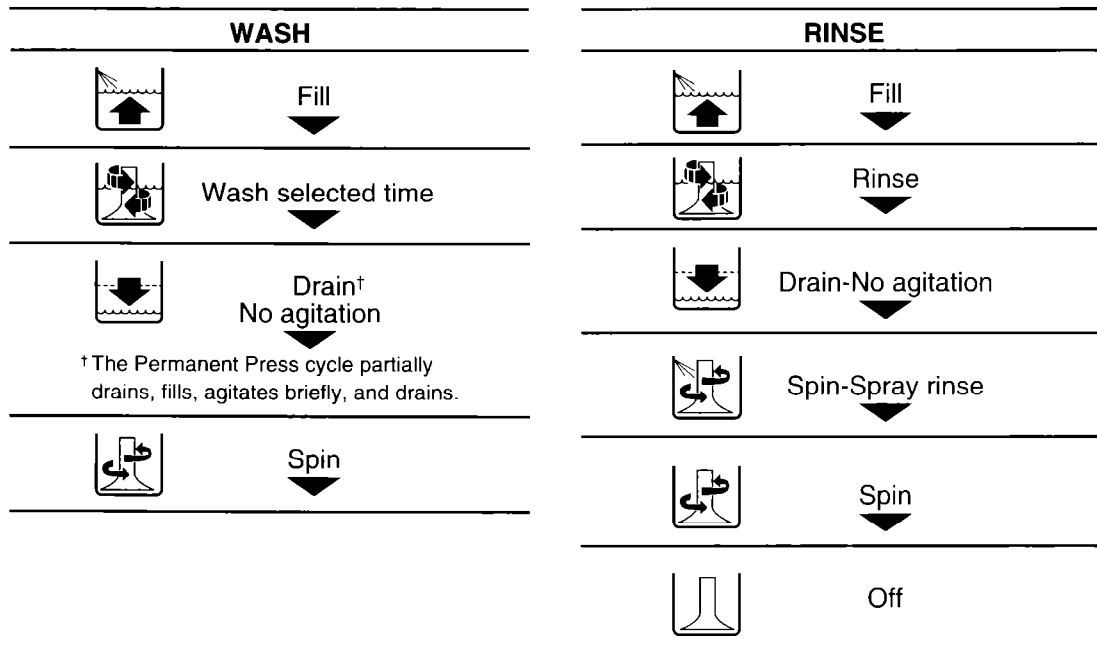

MAGIC CLEAN* lint filter

The lint filter at the bottom of the washer basket cleans itself. During agitation, wash and rinse water pass over the filter, separating the lint from the water. The lint is then spun away from the filter and out of the system during the spin part of the cycle.

If your washer drains into a tub, remove any lint collected in the tub or strainer.

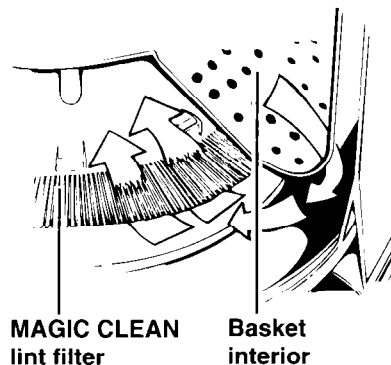

Adding liquid chlorine bleach

Use your washer's liquid chlorine bleach dispenser to add bleach to the wash load. Always measure liquid chlorine bleach. Do not guess. Never use more than 250 mL (1 cup) for a full load. Use less with lower water level settings. Follow manufacturer's directions for safe use. Use a cup with a pouring spout to avoid spilling.

1. Load the washer.
2. Pour measured chlorine bleach carefully into the dispenser. Do not let bleach splash, drip, or run down into washer basket. Undiluted bleach will damage any fabric it touches.
3. Start the washer. Bleach will be diluted automatically during wash part of cycle.

NOTE: Do not use this dispenser to add powdered chlorine or colour safe bleach to your wash load. The dispenser is for liquid chlorine bleach use only.

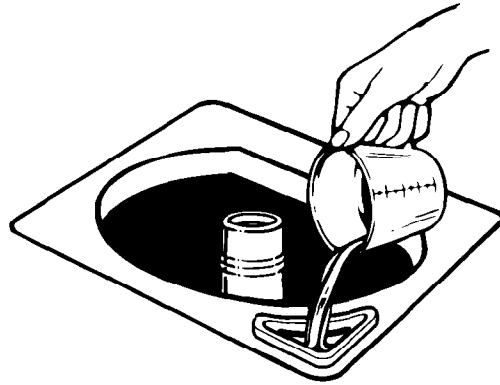

Adding liquid fabric softener

No fabric softener dispenser installed

- Always dilute fabric softeners with 125 mL (½ cup) to 250 mL (1 cup) warm water. Undiluted fabric softener can stain fabrics.
- Add diluted fabric softener only in the final rinse.
- Fabric softeners should not be mixed with other laundry products because greasy stains may form. If stains form, remove by wetting the stain and rubbing with liquid detergent or a bar of soap. Rewash the stained item.
- Too much fabric softener can make some items (diapers and towels) nonabsorbent. If this happens, use less fabric softener, or do not use it every time.

Fabric softener dispenser installed

1. Add detergent and load clothes into the basket.
2. Pour liquid fabric softener into the dispenser using the amount recommended on the package. Avoid dripping or spilling any fabric softener on the load.
3. Dilute fabric softener with warm water. Fill dispenser with warm water until liquid reaches the cross bar in the opening.
4. Start the washer. Diluted fabric softener will be added to the load during the final rinse.

NOTE: Do not stop the washer before the rinse part of the cycle begins. Staining can occur.

5. Flush dispenser periodically with warm water, as illustrated.
 - To remove the dispenser, grasp the top of the dispenser with both hands. Squeeze and push upward with thumbs to remove.
 - Clean dispenser by holding under water faucet. Replace after cleaning.

NOTE: Do not wash clothes with this dispenser removed. Do not add detergent or bleach to dispenser. The dispenser is for liquid fabric softener use only.

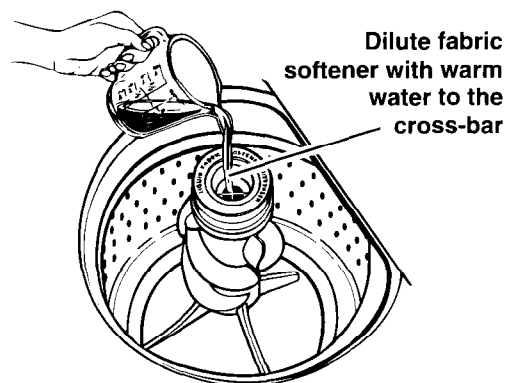

Dilute fabric softener with warm water to the cross-bar

Add fabric softener and water

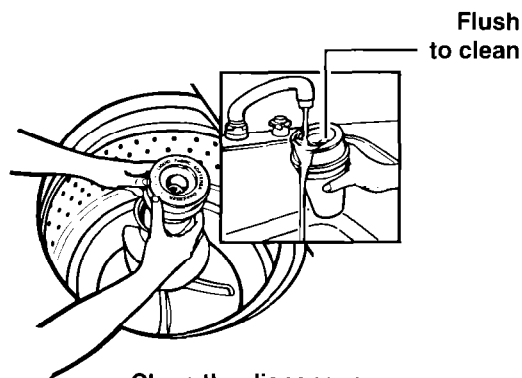

Flush to clean

Clean the dispenser

Caring for Your Washer

Proper care of your washer can extend its life. This section explains how to care for your washer properly and safely.

Cleaning your washer

Exterior

Wipe up detergent, bleach, and other spills with a soft, damp cloth or sponge as they occur. Occasionally wipe the outside of the washer to keep it looking like new.



Do not put sharp or metal objects in your washer. They can damage the finish. Check all pockets for pins, clips, money, bolts, nuts, etc. Do not lay these objects on your washer after emptying pockets.

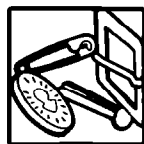

Interior

Clean interior with 250 mL (1 cup) of chlorine bleach mixed with 500 mL (2 cups) of detergent. Run washer through a complete cycle using hot water. Repeat process if necessary.

NOTE: Remove hard water deposits using cleaners labeled as washer safe only.

Winter storage or moving care

Install and store your washer where it will not freeze. Because some water may stay in the hoses, freezing can damage your washer. If storing or moving your washer during freezing weather, winterize it.

To winterize washer:

1. Shut off both water faucets.
2. Disconnect and drain water inlet hoses.
3. Put 1L (1 quart) of R.V.-type antifreeze in the basket.
4. Run washer on a drain and spin setting (see page 8) for about 30 seconds to mix the antifreeze and water.
5. Unplug the power supply cord.

To use washer again:

1. Flush water pipes and hoses.
2. Reconnect water inlet hoses.
3. Turn on both water faucets.
4. Reconnect power supply cord.
5. Run the washer through a complete cycle with 250 mL (1 cup) of detergent to clean out antifreeze.

Non-use or vacation care

You should operate your washer only when you are at home. If you will be on vacation or not using your washer for an extended period of time, you should:

- Unplug the power supply cord or turn off electrical power to the washer.

- Turn off the water supply to the washer. This helps avoid accidental flooding (due to a water pressure surge) while you are away.

Laundry Tips

This section reviews proper laundering techniques and gives you additional washing information.

Preparing clothes for washing



- Close zippers, snaps, and hooks to avoid snagging other items. Remove pins, buckles, and other hard objects to avoid scratching the washer interior. Remove non-washable trim and ornaments.
- Empty pockets and turn them inside out.
- Turn down cuffs, brush away lint and dirt.
- Turn synthetic knits inside out to avoid pilling.
- Tie strings and sashes so they will not tangle.
- Mend tears, loose hems, and seams.
- Treat spots and stains. (See “Removing Stains” on pages 17-19.)
- Stained or wet garments should be washed promptly for best results.

Sorting



- Separate heavily soiled items from lightly soiled ones, even if they would normally be washed together. Separate lint givers (towels, chenille) from lint takers (corduroy, synthetics, permanent press). When possible, turn lint givers inside out.
- Separate dark colours from light colours, colourfast items from noncolourfast items.
- Sort by fabric and construction (sturdy cottons, knits, delicate items).

Loading



- Drop items into washer loosely. Fill to the top of the basket, (top row of holes). Do not wrap items around the agitator. Items should move easily through wash water for best cleaning and wrinkle-free results. Items should sink and reappear later.
- Load washer properly and select correct load size setting. Overloading or packing the machine, and selecting a setting too small for the wash load can:
 - cause poor cleaning.
 - increase wrinkling.
 - create excessive lint.
 - wear out items faster (because of pilling).
- Load by the amount of space items take up, not by their weight.
- Mix large and small items in each load.
- Load evenly to maintain washer balance. An off-balance load can make the washer vibrate during spin.
- Use a large load size setting to reduce wrinkling with permanent press clothes and some synthetic knits. These items should have more room to move in the water than heavy items (towels, jeans).
- Reduce wash time when using a small load size setting. Loads with only a few small items need less wash time.



continued on next page

LAUNDRY TIPS

Loading suggestions

For these suggested full-sized loads, set the Load Size Selector to the highest load size setting.

| LARGE CAPACITY WASHERS | | | |
|---|--|--|---|
| Heavy Work Clothes 2 pair pants 3 shirts 3 pair jeans 1 coverall | Permanent Press 1 double sheet 1 tablecloth 1 dress 1 blouse 2 slacks 3 shirts 2 pillowcases | Mixed Load 2 double or 1 king size sheet(s) 4 pillowcases 6 T-shirts 6 pair shorts 2 shirts 2 blouses 6 handkerchiefs | Towels 8 bath towels 8 hand towels 10 wash cloths 1 bath mat |
| Knits 2 slacks 2 blouses 4 shirts 4 tops 2 dresses | | | Delicates 2 camisoles 4 slips 4 panties 2 bras 2 nighties |

| SUPER CAPACITY WASHERS | | | |
|--|---|--|---|
| Heavy Work Clothes 3 pair pants 3 shirts 4 pair jeans 1 coverall 1 overall | Permanent Press 2 double or 1 king size sheet(s) 1 tablecloth 1 dress 1 blouse 2 slacks 3 shirts 2 pillowcases | Mixed Load 3 double sheets 4 pillowcases 8 T-shirts 6 pair shorts 2 shirts 2 blouses 8 handkerchiefs | Towels 10 bath towels 10 hand towels 14 wash cloths 1 bath mat |
| Knits 3 slacks 3 blouses 6 shirts 4 tops 4 dresses | | | Delicates 3 camisoles 1 quilted robe 4 slips 4 panties 2 bras 2 nighties 1 baby's dress |

Saving energy

- Use warm or cold wash water for most loads. Use hot water only when washing heavy, greasy soils or whites.
- Use cold rinses.
- Wash full loads.
- Use lower water levels when washing small loads.
- Avoid rewashing. Use enough detergent and pretreat stains or heavy soils. Use the cycles and wash times recommended for the fabric and soil.
- Use your washer during off-peak hours – usually early morning and late evening. (Ask your power company.)

Water guidelines

Selecting water temperatures

| WASH WATER TEMPERATURE† | SUGGESTED FABRICS | COMMENTS |
|--|--|--|
| HOT 54°C (130°F) or above | <ul style="list-style-type: none"> • Work clothes • Sturdy whites/colourfast pastels • Diapers | <ul style="list-style-type: none"> • Best cleaning for heavily soiled items • Removes oils, perspiration, greasy soils and stains • Prevents graying or yellowing |
| WARM 32-44°C (90-110°F) | <ul style="list-style-type: none"> • Dark/noncolourfast colours • Permanent press items • Nylon, polyester, acrylics, silks, woollens • Knits/delicate fabrics | <ul style="list-style-type: none"> • Best for moderately soiled to lightly soiled items • Safe for most fabric finishes • Less fading and dye bleeding • Reduces wrinkling |
| COLD 21-32°C (70-90°F) | <ul style="list-style-type: none"> • Extra-sensitive colours • Noncolourfast items • Hand washables | <ul style="list-style-type: none"> • Best for very lightly soiled items • Saves hot water • Best rinse water temperature |

† The washer features cold rinses for all wash temperatures. In addition, on some models, warm rinses are available with hot washes and warm washes. Warm rinse water provides better water extraction than cold rinse water, but may increase wrinkling when line drying. In cold climates, warm rinse water also provides a more comfortable temperature for handling the wash load.

Checking hot water temperature

Your hot water should be 54°C (130°F) or above. If you do not know your hot water temperature, you can check it easily. You may need to raise the temperature of your water heater. To check your hot water:

1. Fill a pan with the hottest water available from the faucet that fills your washer.
NOTE: If you do not have a faucet at your washer site, collect the water from the faucet closest to your washer.
2. Place a candy thermometer or cooking thermometer in the water to check the temperature.

NOTE: In wash-water temperatures colder than 21°C (70°F), detergents do not dissolve well. Also, soils may be difficult to remove, and some fabrics may retain wear wrinkles and may have increased pilling.

Water hardness

Many poor washing results can be traced to the hardness of the wash water. To check your water hardness:

- City water – ask the city water company.
- Well water – ask the local water authority.

Ask for the mineral content in grains/gallon or parts/million. If your water is more than 8 grains/gallon or more than 137 parts/million, you should consider:

- Installing a water softener.
- Using more detergent.
- Using a packaged water conditioner.
- Not using soap.

Washing special-care items

Most garments and household textiles have care labels with laundering instructions. **Always follow care label directions when they are available.** Below are general washing instructions for some special washables.

| ITEM | CARE INSTRUCTIONS |
|---|--|
| Blankets (electric or woollen) | Pretreat spots and stains. Select water temperature, cycle, and time according to the type of blanket being washed. Two rinses may be necessary. Check care label to see if manufacturer recommends machine washing. |
| Curtains, drapes, slipcovers | Wash small loads. Crowding may cause wrinkling. Replace slipcovers while still slightly damp. They will dry to fit tightly. NOTE: Sun-damaged curtains and draperies will tear whether hand or machine washed. |
| Diapers | When using chlorine bleach for soaking, add extra detergent to the load. Avoid overuse of fabric softeners – absorbency will be reduced. |
| Elastic, spandex | Elastic picks up oil from the body. Oil can damage elastic. Wash often to reduce the damage. Use warm water and sufficient detergent to remove oils. Do not use chlorine bleach. |
| Flame-retardant clothing | Items will be clearly labeled as flame-retardant. Follow manufacturer's instructions to retain flame-retardant qualities. |
| Knits | Knits are comfortable to wear because they stretch. However, this means that knits are more likely to be stretched and damaged when washed (especially bulky knits). Knits made of synthetic fabrics such as polyester, nylon, and acrylic tend to keep their original shape more than a knit made of cotton or ramie. |
| Pillows, stuffed toys | Washing feather pillows is not recommended unless they will be dried in a dryer. |
| Plastic, rubber items | Treat as delicate items. Wash in warm water. Wash small items in a mesh bag. |
| Quilts, bedspreads | Do not wash cotton-filled comforters unless they are quilted or stitched. Tucked cotton batting tends to slip and become lumpy. An extra rinse may be necessary. |
| Scatter rugs | Shake or vacuum rugs to remove loose dirt. Wash more than one rug at a time. If washing only one rug, add bath towels to balance the load. |
| Snowsuits, jackets | Wash only one or two items at a time. You may need to stop the washer occasionally to press air from the items being washed. An extra rinse may be necessary. |

Removing Stains

Stained, heavily soiled, or greasy items may need to be prewashed or soaked for best results. Soaking helps remove protein-type stains like blood, milk, or grass. Prewashing helps loosen soil before washing.

Stain removal rules

- Use warm water for soaking or prewashing stained laundry. Hot water can set stains.
- Most stains are easier to remove when they are fresh. Old or set stains may not come out. Follow package directions for pretreatment products.
- Before treating any stain, find out what kind of stain it is, how old the stain is, what kind of fabric it is, and if the fabric is colourfast. (Check the care label.)
- Washing and drying can set some stains.
- Start with cold or warm water. Hot water can set some stains.
- When bleach is recommended, use a bleach that is safe for the fabric.
- Test stain removers on an inside seam or hidden corner of the item to see if the colour is removed.
- Put the stained area face down on a paper towel or white cloth. Apply the stain remover to the back of the stain. This forces the stain off the fabric instead of through it.
- Meat tenderizer or enzyme presoaks help break down some protein stains so they are easier to remove.

Stain removal guide

| STAIN | TO REMOVE |
|----------------------------------|---|
| Alcoholic beverage | These stains turn brown with age, so treat immediately. Sponge or soak fresh stains with cold water. Wash. If stain remains, soak 15 minutes in a solution of lukewarm water, liquid detergent, and a few drops of white vinegar. Rinse. Wash. |
| Blood | Rinse immediately or soak in cold water with enzyme presoak for 30 minutes or longer. Rinse. Rub detergent into any remaining stains. Rinse. If stain remains, put a few drops of 3% hydrogen peroxide on stain for 3-5 minutes. Rinse thoroughly. Wash. |
| Chewing gum | Use ice to make gum hard. Scrape off what you can. Sponge with a nonflammable fabric cleaner. Let dry. Wash. |
| Chocolate or coffee | Sponge immediately with a nonflammable fabric cleaner or apply a prewash soil and stain remover. Rinse. Wash. If stain remains, apply a liquid detergent to stain or soak in warm water with an enzyme presoak. Rewash. |
| Crayon and candle wax | Scrape off excess with a dull knife. Place fabric between two blotters or facial tissue. Press with warm iron. Remove colour stain with nonflammable fabric cleaner. Hand wash until stain is gone. If full load is crayon stained, take to cleaners or coin-operated dry cleaning machine. |
| Cream, milk, or ice cream | Sponge with a nonflammable fabric cleaner, or a prewash soil and stain remover. Rinse. Wash. Repeat if necessary. If stain remains, apply a few drops of liquid detergent and a few drops of ammonia. Blot dry and rinse. If stain remains, soak in an enzyme presoak. Wash. |

continued on next page

REMOVING STAINS

| STAIN | TO REMOVE |
|--|--|
| Deodorants and anti-perspirants | <p>Light stain: Treat with liquid detergent or your regular laundry detergent. Wash in hottest water safe for fabric.</p> <p>Heavy stain: Place face down on towel and treat with a paste of ammonia and colour safe bleach. Let stand for 30 minutes. Wash in hottest water safe for fabric.</p> |
| Fat, grease, or oil | <p>Items soiled with vegetable or cooking oil should not be washed or dried. See vegetable/cooking oil Warning on page 3. For other types of greasy stains, use one of the methods below:</p> <ul style="list-style-type: none"> • Use pretreatment stain remover. Follow label directions. Wash in hottest water safe for fabric. • Use talcum powder to absorb as much grease as possible. Sponge with a nonflammable fabric cleaner. Rinse. Wash. • Treat with liquid detergent or rub a detergent paste on the stain. Wash using hottest water safe for fabric. |
| Fruit stains | <p>Fresh stains: Soak immediately in cool water. Wash. If stain remains, cover area with a paste made of colour safe bleach, a few drops of hot water and a few drops of ammonia. Wait 15 to 30 minutes. Wash.</p> <p>Old stains: Sponge with white vinegar. Rinse. Repeat procedure for fresh stains.</p> |
| Grass or green vegetables | <p>Soak in warm or cold water with an enzyme presoak for at least 30 minutes, or sponge with denatured alcohol. Wash in water temperature and bleach safe for the fabric. For coloured fabrics, check colourfastness before applying alcohol. For acetate, sponge with a nonflammable fabric cleaner. If stain remains, bleach with 3% hydrogen peroxide. Rinse. Rewash.</p> |
| Ink or ballpoint pen ink | <p>Spray stain with an aerosol hair spray or rubbing alcohol. Sponge stain continuously until all bleeding stops. Let dry. Repeat if necessary. Wash. If stain remains, bleach if safe for fabric. (India and other indelible inks are almost impossible to remove completely.)</p> |
| Iron or rust | <p>Coloured or noncolourfast items: Apply lemon juice and salt. Place in the sun to dry. Rinse thoroughly. Repeat if necessary.</p> <p>White or colourfast items: Try a rust remover. Test first on inside seam or hem. Some rust removers are not washer safe. Follow package directions.</p> |
| Ketchup or tomato products | <p>Sponge immediately with a nonflammable fabric cleaner or apply a prewash soil and stain remover. Rinse. Wash. If stain remains, apply a liquid detergent to stain or soak in warm water with an enzyme presoak. Rewash.</p> |
| Lipstick | <p>Apply nonflammable fabric cleaner or prewash soil and stain remover. Blot with absorbent material. Repeat if necessary. Rinse. If stain still remains, rub with liquid detergent. Wash.</p> |

REMOVING STAINS

| STAIN | TO REMOVE |
|------------------------|--|
| Meat juice, egg | Scrape off excess with a dull knife. Soak in cold or warm water with enzyme presoak at least 30 minutes, or treat stains with a nonflammable fabric cleaner. Wash. |
| Mildew | Wash in hottest water safe for fabric. If stain remains, soak in warm water and a colour safe bleach for 15 to 30 minutes. Rewash. (Old mildew stains are almost impossible to remove. Mildew fungus destroys or weakens fabrics.) An alternative to bleach is to treat with salt and lemon juice and dry in direct sunlight. Rinse and rewash. Mildew may form if wet or damp laundry remains in your washer for extended periods of time. To prevent mildew, promptly dry laundry after washing. |
| Mustard | Treat immediately. Scrape off excess mustard. Sponge with a nonflammable fabric cleaner or a prewash soil and stain remover. Rinse. Work liquid detergent and a few drops of vinegar into stain. Rinse. If stain remains, apply 3% hydrogen peroxide. Rinse and wash. |
| Paint | Hand wash paint-stained items. Water base: Treat stains while still wet. (These paints cannot be removed after they have dried.) Rinse in warm water to flush out paint. Sponge with a nonflammable fabric cleaner. Rinse. Wash. Oil base: Scrape off fresh paint. Sponge with a nonflammable fabric cleaner or treat stain with recommended thinner. While stain is still wet with solvent, rub liquid detergent into it. Wash with hottest water safe for fabric. |
| Perspiration | Remove stains before ironing. Perspiration stains may weaken fabric. Wash or sponge stain thoroughly with detergent and warm water. If perspiration has changed the colour of the fabric, use one of the following treatments: Fresh stains: Apply ammonia to stain. Rinse. Launder to remove ammonia odour. Old stains: Apply white vinegar to stain. Rinse. Launder to remove vinegar odour. |
| Scorch | Severe scorch cannot be removed. Wet stain with 3% hydrogen peroxide. Cover with a dry cloth and press with an iron as hot as is safe for fabric. Rinse well. Wash. OR Wet with lemon juice and spread in the sun to dry. Wash. |
| Soft drinks | Sponge immediately with cold water and alcohol. Heat and detergent may set stain. |

Troubleshooting

Most laundering problems are easily solved if you understand the cause. Check the following list for common laundry problems and the next page for common washer problems. If you need further assistance, see page 22.

Common problems

| PROBLEM | CAUSE |
|--------------------------------------|---|
| Brown, yellow stains | <ul style="list-style-type: none"> • Chlorine staining • Iron in water heater or pipes; iron and manganese in water |
| Dye transfer | <ul style="list-style-type: none"> • Improper sorting • Load not immediately removed from washer after end of cycle |
| Gray whites, dingy colours | <ul style="list-style-type: none"> • Improper sorting • Water temperature too low • Not enough detergent • Using soap in very hard water (use detergent in hard water) |
| Greasy looking spots | <ul style="list-style-type: none"> • Fabric softener poured directly on clothes • Not enough detergent, or dispenser not used |
| Lint | <ul style="list-style-type: none"> • Improper sorting • Paper or tissue in pockets • Pilling being mistaken for lint • Not enough detergent |
| Load too wet after spin | <ul style="list-style-type: none"> • Cold rinses • Cycle stopped before spinning is complete |
| Shrinking | <ul style="list-style-type: none"> • Fabric type (some knits stretch during manufacturing – laundering returns fabric to original size) • Care label directions not followed |
| Snags, rips, and holes | <ul style="list-style-type: none"> • Items damaged before washing • Misuse of chlorine bleach (do not pour directly on clothes); dispenser not used • Sharp items not removed from pockets; fasteners not fastened |
| Stiff, rough fabrics | <ul style="list-style-type: none"> • Using soap in very hard water (use detergent in hard water) • Not enough detergent • Line drying |
| Twisting/ Tangling | <ul style="list-style-type: none"> • Overloading • Clothes wrapped around agitator |
| Wrinkling | <ul style="list-style-type: none"> • Overloading (leave more room for permanent press and knits) • Load not immediately removed from washer after cycle • Warm rinse water • Cycle selection incorrect |
| Yellow areas (from body oils) | <ul style="list-style-type: none"> • Water temperature too low • Not enough detergent |

Common washer problems

Before calling for service, check these:

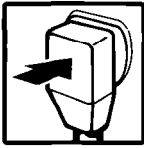

Is the power cord firmly plugged into a live outlet with proper voltage?

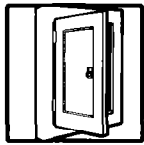

Have you blown a household fuse or tripped a circuit breaker? Has a time-delay fuse been used?



Are both the hot and cold water faucets turned on?



Are the water hoses kinked or clogged?

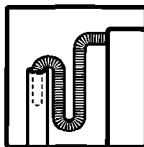

Is the drain hose lower than the water level in the washer? It must be higher.

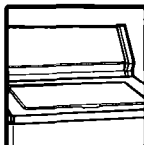

Is the lid closed?

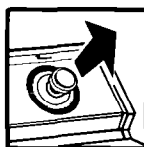

Is the Cycle Control Knob set and pulled out?

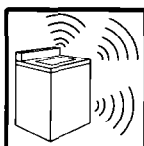

Is the washer making noises or vibrating?
Is the wash load properly distributed around the agitator?

NOTE: Washer stops briefly during a wash cycle. These pauses are normal.

If none of these items was causing your problem, see "Requesting Assistance or Service" on page 22.

Requesting Assistance or Service

Before calling for assistance or service, please check "Troubleshooting" on pages 20-21. It may save you the cost of a service call. If you still need help, follow the instructions below.

1. If your problem is not due to any of the items listed in the "Troubleshooting" section ...

Contact the dealer from whom you purchased the washer, or an authorized Whirlpool* service company.

2. If you need FSP* replacement parts ...

FSP is a protected trademark of Whirlpool Corporation* for quality parts. Look for this symbol of quality whenever you need a replacement part for your WHIRLPOOL appliance. FSP replacement parts will fit right and work right, because they are made to the same exacting specifications used to build every new WHIRLPOOL appliance.

To locate FSP replacement parts in your area, contact the dealer from whom you purchased the washer, or an authorized Whirlpool service company.

Gearcase assembly covered by your warranty



NOTE: If the power supply cord of this washer is damaged, it must be replaced by a special cord (Part Number 3353308) available from the dealer from whom you purchased the washer or an authorized Whirlpool service company.

Should you require any assistance or service, phone the Whirlpool Service Company on:

| | | | |
|---------------|---------------|------------|----------------|
| Sydney | (02) 742 8222 | Canberra | (065) 239 1622 |
| Hobart | (002) 28 0121 | Melbourne | (03) 235 3500 |
| Central Coast | (008) 04 5584 | Gold Coast | (075) 35 3052 |
| Brisbane | (07) 844 0191 | Townsville | (077) 79 7422 |
| Wollongong | (042) 28 0133 | Adelaide | (08) 348 2555 |
| New Castle | (049) 62 1994 | Perth | (09) 277 7166 |

WHIRLPOOL^{*}

Automatic Washer

Warranty

Outside the United States a different warranty may apply. For details, please contact your authorized Whirlpool distributor or military exchange.

| LENGTH OF WARRANTY | WHIRLPOOL WILL PAY FOR |
|--|---|
| FULL ONE-YEAR WARRANTY From Date of Purchase | FSP* replacement parts and repair labour to correct defects in materials or workmanship. Service must be provided by an authorized Whirlpool service company. |
| LIMITED FIVE-YEAR WARRANTY From Date of Purchase | FSP replacement parts for any part of gearcase assembly if defective in materials or workmanship. The gearcase assembly is shown in the "Requesting Assistance or Service" section of this book. FSP replacement parts for any top and lid rust. |
| LIMITED TEN-YEAR WARRANTY From Date of Purchase | FSP replacement of outer tub should it crack, or fail to contain water, due to defective materials or workmanship. |
| WHIRLPOOL WILL NOT PAY FOR | |
| A. Service calls to: <ol style="list-style-type: none"> 1. Correct the installation of your washer. 2. Instruct you how to use your washer. 3. Replace house fuses or correct house wiring or plumbing. B. Repairs when your washer is used in other than normal, single-family household use. C. Pickup and delivery. Your washer is designed to be repaired in the home. D. Damage to your washer caused by accident, misuse, fire, flood, acts of God, or use of products not approved by Whirlpool. E. Any labour costs during the limited warranties. F. Repairs to parts or systems caused by unauthorized modifications made to the appliance. | |

6-94

WHIRLPOOL CORPORATION SHALL NOT BE LIABLE FOR INCIDENTAL OR CONSEQUENTIAL DAMAGES.

Specific warranty details are outlined above. However, the benefits conferred by this express warranty are additional to all other conditions, warranties, guarantees, rights and remedies expressed or implied by the Trade Practices Act and similar State or Territory laws and all other obligations and liabilities on the part of the manufacturer or supplier and nothing contained herein shall restrict or modify such rights, remedies, obligations or liabilities.